

- » Highly dynamic 3-phase BLDC motor with 8-pole neodymium magnet
- » Integrated speed control
- » Selectable rotational direction
- » Can be combined with gearboxes within our modular system
- » As IP construction (BG 45 dGo) on request
- » Analog speed input 0...10V

- » Hochdynamischer 3-strängiger EC-Motor mit 8-poligem Neodymmagnet
- » Integrierte Geschwindigkeitsregelung
- » Drehrichtung wählbar
- » Im modularen Baukasten kombinierbar mit Getrieben
- » Als IP-Bauweise (BG 45 dGo) auf Anfrage
- » Analoges Geschwindigkeitseingang 0...10V

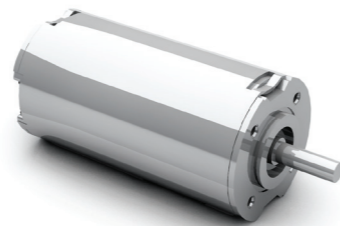

Block commutation

Digital inputs

Analog inputs

Digital outputs

24 cpr

24

Premium efficiency

Protection class (up to)

Certification

Certification (>36 V only)

Vibration resistance

Data preliminary/ Technische Daten vorläufig		BG 42x15 dGo		BG 42x30 dGo		BG 42x45 dGo
Nominal voltage/ Nennspannung	VDC	12	24	12	24	24
Nominal current/ Nennstrom	A ¹	4.7	2.3	6.5	3.6	4.9
Nominal torque/ Nennmoment	Nm ¹	0.113	0.118	0.152	0.182	0.246
Nominal speed/ Nenn Drehzahl	rpm ¹	3540	3540	3650	3600	3590
Maximum torque/ Maximales Moment	Nm ¹	0.432	0.615	0.459	0.667	1.001
No load speed/ Leerlaufdrehzahl	rpm ¹	4400	4300	4200	4200	4200
Nominal output power/ Dauerabgabeleistung	W ¹	43	45	60	70	96
Maximum output power/ Maximale Abgabeleistung	W	85	103	105	143	214
Torque constant/ Drehmomentkonstante	Nm A ⁻¹	0.028	0.058	0.029	0.061	0.055
Peak current/ Zulässiger Spitzenstrom	A ¹	14.25	9.75	14.25	9.75	14.75
Rotor inertia/ Rotor Trägheitsmoment	gcm ²	24	24	44	44	64
Weight of motor/ Motorgewicht	kg	0.36	0.36	0.47	0.47	0.58

¹) Δθw = 100 K; ²) θ_R = 20°C ³) at nominal point/ im Nennpunkt

Modular System/ Modulares Baukastensystem

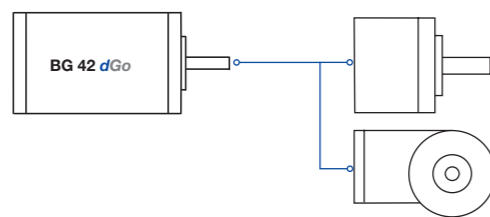

- » Planetary Gearboxes/
Planetengetriebe
 - PLG 42 S
 - PLG 52
 - PLG 40 LB
- » Angular Gearboxes/
Winkelgetriebe
 - SG 45
 - SG 62

You can individually configure your suitable product and download technical data and drawings for the combination at www.dunkermotoren.com/en/configuration/.
Unter www.dunkermotoren.de/konfigurator können Sie Ihr passendes Produkt individuell konfigurieren und technische Daten und Zeichnung für die Kombination herunterladen.

Dimensions in mm/ Maßzeichnung in mm

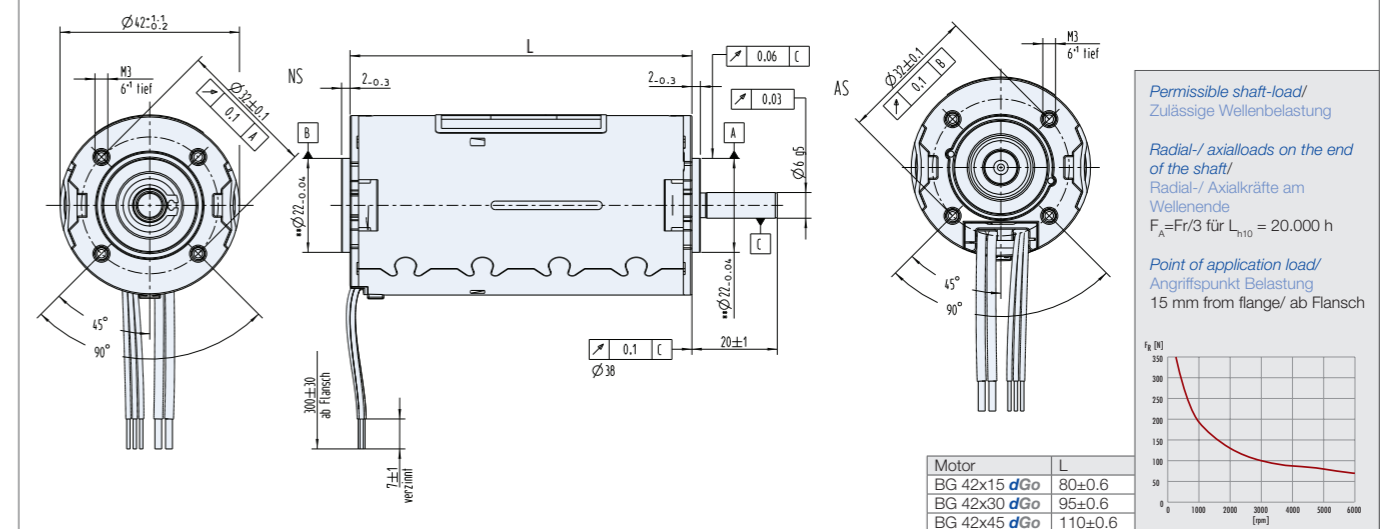

Characteristic diagram/ Belastungskennlinien

In accordance with/ Belastungskennlinien gezeichnet nach EN 60034

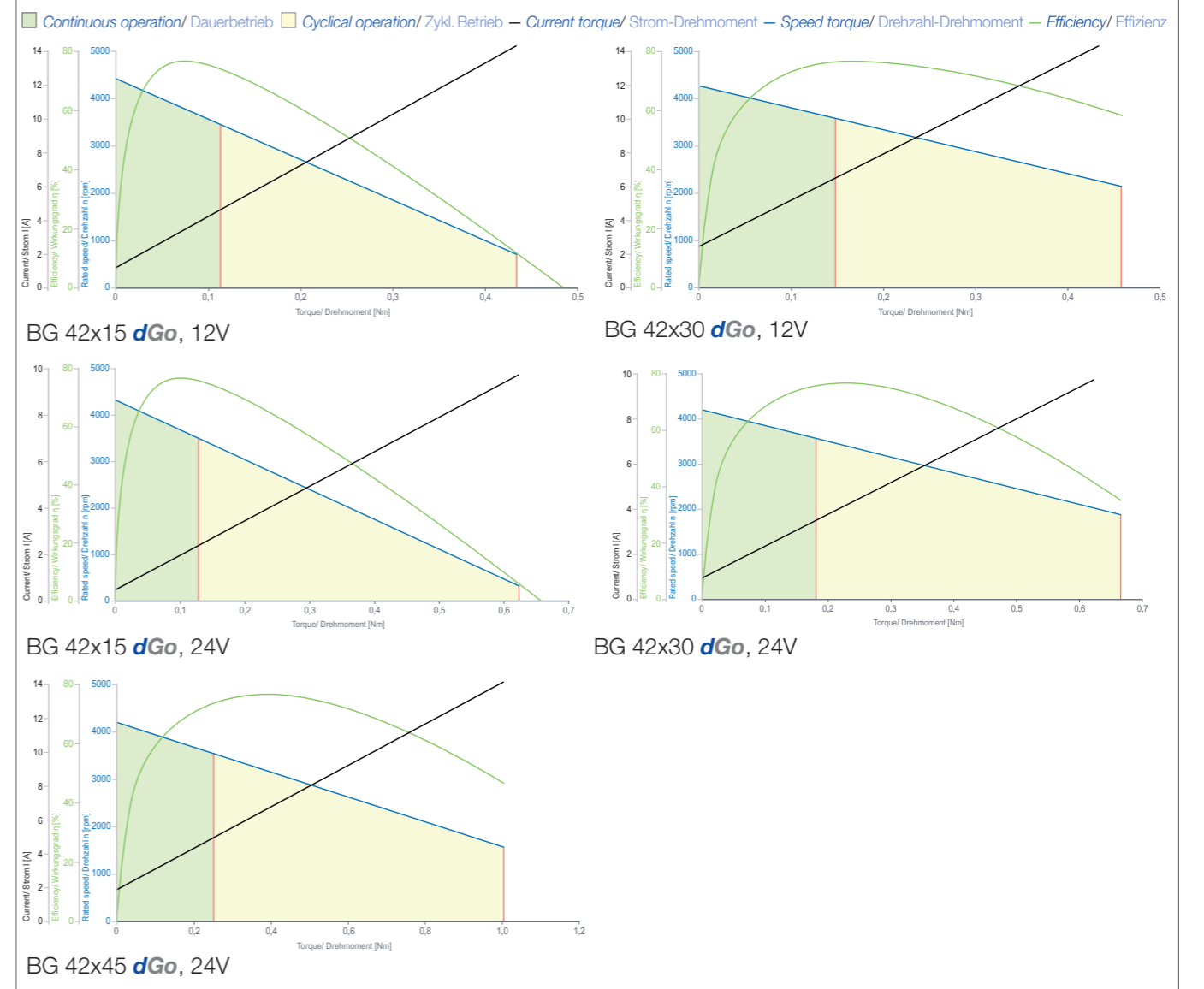

■ Preferred series/ Vorzugsreihe ■ Standard product/ Standardprodukt ■ On request/ auf Anfrage

Authorised, valued-added distributor

Australia & New Zealand



Powerbox Australia Pty Ltd

Sydney Head Office
4 Beaumont Road,
Mt Kuring-Gai, NSW 2080
Australia

 1800 251 380

 sales@powerbox.com.au

 powerbox.com.au

Powerbox Pacific Ltd

New Zealand Sales Office
1a Henry Rose Place,
Albany, Auckland
New Zealand 0632

 09 4158 320

 sales@powerbox.co.nz

 powerbox.co.nz